

Catalogue **BUROTICA**



Organization | Planning | Customization



BUROTICA

Floor Boxes	4
Workstations	6
Desktop Workstations	8
Minicolumns	10
Columns	10
Mec Q45 System	12
Technical Information	15





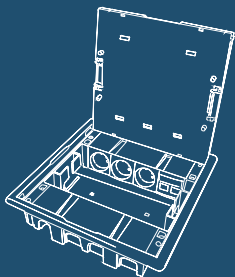





Floor Boxes

NEW



In constantly evolving work environments, we have designed solutions for a multiplicity of requirements. Whether they are **solutions for new workspaces** or **reconfiguration of existing ones**.

Floor Boxes

		Ref.	Colour
	<p>Floor Box - 4 Modules External dimensions (mm): ø 139 Supplied with separate claws See Technical Data Sheet - page 16</p>	83002 C	CZ AT BR
	<p>Flush Mounting Box for Floor Box - 4 Modules Supplied with assembled claws</p>	83052	–
	<p>Floor Box - 8 Modules External dimensions (mm): 256 x 166 Supplied with assembled claws See Technical Data Sheet - page 17 to 18</p>	NEW 83004 C	CZ AT
	<p>Flush Mounting Box for Floor Box - 8 Modules Supplied with Polystyrene Block</p>	NEW 83054	–
	<p>Floor Box - 12 Modules External dimensions (mm): 256 x 211 Supplied with assembled claws See Technical Data Sheet - page 17 to 18</p>	NEW 83006 C	CZ AT
	<p>Flush Mounting Box for Floor Box - 12 Modules Supplied with Polystyrene Block</p>	NEW 83056	–
	<p>Floor Box - 16 Modules External dimensions (mm): 256 x 256 Supplied with assembled claws See Technical Data Sheet - page 17 to 18</p>	83008 C	CZ AT
	<p>Floor Box with Stainless Steel Cover - 16 Modules External dimensions (mm): 256 x 256 Supplied with assembled claws See Technical Data Sheet - page 17 to 18</p>	83008 C	ZI AI
	<p>Flush Mounting Box for Floor Box - 16 Modules Supplied with Polystyrene Block</p>	83058	–
	<p>Floor Box - 24 Modules External dimensions (mm): 256 x 369 Supplied with assembled claws See Technical Data Sheet - page 17 to 18</p>	NEW 83012 C	CZ AT
	<p>Flush Mounting Box for Floor Box - 24 Modules Supplied with Polystyrene Block</p>	NEW 83062	–

C - Complete Device. | BR - White; CZ - Grey; AT - Anthracite; ZI - Grey/Inox; AI - Anthracite/Inox.
 Applicable with MEC Q45 devices.

Workstations



New Colours















We develop solutions that merge into the decoration and aesthetics of existing spaces, respecting their identity.

Its modularity and exchange of customised solutions allow **quick adaptation and reconfiguration in any workspace.**

Know our solutions and new colours.

Workstations

FLUSH MOUNTING		Ref.	Colour
	<p>Workstation Flush Mounting - 2 x 4 Modules External dimensions (mm): 185 x 170 x 50 See Technical Data Sheet - page from 22 to 23</p>	83401 S	
	<p>Workstation Flush Mounting - 3 x 4 Modules External dimensions (mm): 245 x 170 x 50 See Technical Data Sheet - page from 22 to 23</p>	83402 S	BR BM PM AL
	<p>Workstation Flush Mounting - 4 x 4 Modules External dimensions (mm): 305 x 170 x 50 See Technical Data Sheet - page from 22 to 23</p>	83403 S	
	<p>Workstation Flush Mounting 3x4 Modules with 2 Schuko VM + 2 Schuko BR + 2 RJ External dimensions (mm): 245 x 170 x 50 Supplied without connectors See Technical Data Sheet - page from 22 to 23</p>	83402 C	
	<p>Workstation Flush Mounting 3x4 Modules with 2 French Socket VM + 2 French Socket BR + 2 RJ External dimensions (mm): 245 x 170 x 50 Supplied without connectors See Technical Data Sheet - page from 22 to 23</p>	83431 C	BR
	<p>Workstation Flush Mounting with Door - 2 x 8 Modules External dimensions (mm): 260 x 260 x 64 See Technical Data Sheet - page from 24 to 25</p>	83404 S	BR
SURFACE MOUNTING			
	<p>Workstation Surface Mounting - 2 x 4 Modules External dimensions (mm): 187 x 172 x 60 See Technical Data Sheet - page 20 to 21</p>	83411 S	
	<p>Workstation Surface Mounting - 3 x 4 Modules External dimensions (mm): 247 x 172 x 60 See Technical Data Sheet - page 20 to 21</p>	83412 S	
	<p>Workstation Surface Mounting - 4 x 4 Modules External dimensions (mm): 307 x 172 x 60 See Technical Data Sheet - page 20 to 21</p>	83413 S	BR BM PM AL
	<p>Workstation Surface Mounting - 2 x 4 + 4 x 4 Modules External dimensions (mm): 217 x 202 x 60 See Technical Data Sheet - page 19 and 21</p>	83410 S	
	<p>Workstation Surface Mounting 2x4 + 4x4 Modules with 2 Schuko VM + 2 Schuko BR + 2 RJ External dimensions (mm): 217 x 202 x 60 Supplied without connectors See Technical Data Sheet - page 19 and 21</p>	83410 C	
	<p>Workstation Surface Mounting 2x4 + 4x4 Modules with 2 French Socket VM + 2 French Socket BR + 2 RJ External dimensions (mm): 217 x 202 x 60 Supplied without connectors See Technical Data Sheet - page 19 and 21</p>	83441 C	BR
ACCESSORIES			
	<p>MODUS 55 Adapter for Workstations 4 Modules</p>	83420	
	<p>Lid for Trunking Access to Workstations Supplied as a Blind Cover of 4 modules.</p>	83421	

C - Complete Device. S - Semi-assembled | BR - White; BM - Matte White; PM - Matte Black; AL - Aluminium
 Applicable with MEC Q45 devices.

Desktop Workstations



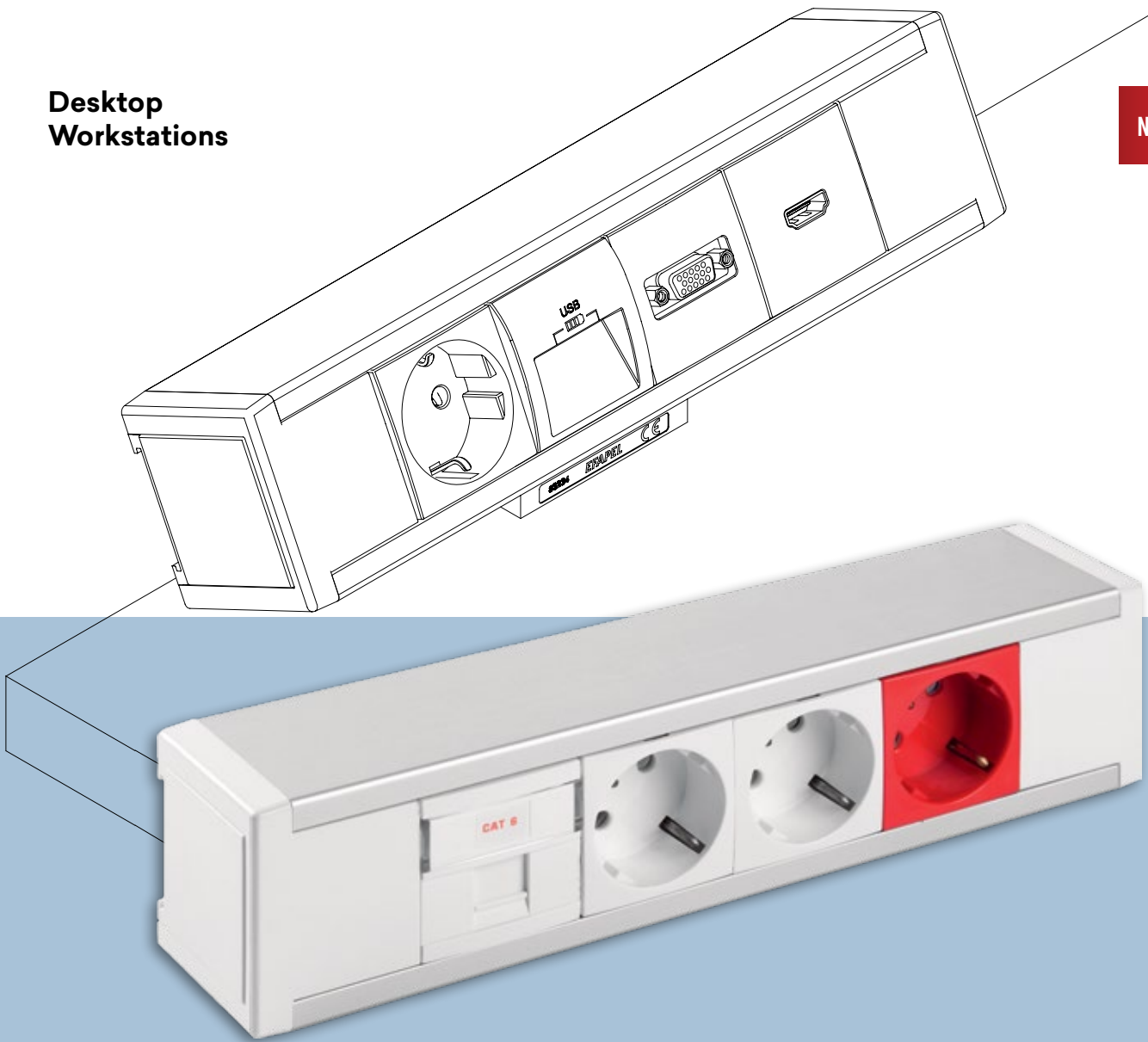















NEW



Easy and practical access to all your connection and connectivity needs.

Easy to apply, versatile and configurable,
Adapted to the new requirements in **workspaces.**

Desktop Workstations

		Ref.	Colour
	Desktop Workstation - 8 + 2 Modules Aluminium. Supplied with 4 Positioners (Ref. 45992) Supplied with 1 Blind Cover Plate (Ref. 45677 S) See Technical Data Sheet - page 26 to 28	83201 S	
	Desktop Workstation - 12 + 2 Modules Aluminium. Supplied with 6 Positioners (Ref. 45992) Supplied with 1 Blind Cover Plate (Ref. 45677 S) See Technical Data Sheet - page 26 to 28	83202 S	BR
ACCESSORIES			
	Top with Adapter for Desktop Workstation - 2 Modules	83230 A	
	Cable Entry Top for Desktop Workstations - 2 Modules	83231 A	
	Module for Fast Connector 2P + T - 2 Modules	NEW 45980 S	BR
	Double Module for 2 Fast Connectors 2P + T - 2 Modules	NEW 45981 S	
	Fast Connector 2P + T Male for Wiring See Technical Data Sheet - page 34	NEW 83150	
	Fast Connector 2P + T Female for Wiring See Technical Data Sheet - page 34	NEW 83151	
	Fast Connector 2P + T Male for Panel See Technical Data Sheet - page 34	NEW 83152	PT VM
	Fast Connector 2P + T Female for Panel See Technical Data Sheet - page 34	NEW 83153	
	Derivation 1 Input / 3 Outputs See Technical Data Sheet - page 34	NEW 83154	
	90° Positioner for 2 Modules Applicable with MEC Q45 devices in Desktop Workstations, Minicolumns and Columns. Enables device assembly with 90° rotation.	45992	
	Cable Gland 3G 1,5 mm	81191	
	Cable Gland 3G 2,5 mm	81192	
	MODUS 55 Adapter for Desktop Workstation, Minicolumns and Columns 4 Modules 2 Poles (for 2 modules devices)	NEW 83220	
	Desktop Workstation Fixing Kit	NEW 83234	-
	Desktop Workstation Profile Dimensions (mm): 2100 / emb. Aluminium. Supplied with Cover (Ref. 83233)	83232	
	Cover for Profile Dimensions (mm): 2100	83233	

S - Semi-assembled. | BR - White; PT - Black; VM - Red.
 Applicable with MEC Q45 devices.

**Minicolumns
and Columns**



1

Ceiling Fastener with Fine Adjustment

The columns offer a quick and easy installation solution:

- ceiling fastener with Screw Rod and fine adjustment up to 750 mm;
- fastener surface with special protrusions that guarantee adhesion to ceilings even on uneven surfaces.

2

Design and Resistance

Manufactured with an aluminium profile, contemporary design and high resistance:

- IK09 degree of mechanical shock protection;
- columns available in two models of different heights, 2850 mm and 3300 mm, with a locking system of high sustainability.

3

Simple and Modular Configuration

Suitable for Mec Q45 devices:

- simple updating and/or configuration of workspaces with the wide range of semi-assembled mechanisms;
- versatile use of semi-assembled mechanisms, such as 45° energy sockets, voice and data sockets, in different workspaces.

Minicolumns









	Ref.	Colour	
	2-Sided Minicolumn 12 + 12 Modules Aluminium. Height (mm): 340 Supplied with Top for Minicolumn (Ref. 83290 A) and Base for Minicolumn (Ref. 83251 A) in CZ (Grey) See Technical Data Sheet - page 29 to 30 and page 33	83282	
	2-Sided Minicolumn 18 + 18 Modules Aluminium Height (mm): 480 Supplied with Top for Minicolumn (Ref. 83290 A) and Base for Minicolumn (Ref. 83251 A) in CZ (Grey) See Technical Data Sheet - page 29 to 30 and page 33	83281	—
	2-Sided Minicolumn 28 + 28 Modules Aluminium. Height (mm): 710 Supplied with Top for Minicolumn (Ref. 83290 A) and Base for Minicolumn (Ref. 83251 A) in CZ (Grey) See Technical Data Sheet - page 29 to 30 and page 33	83283	

Columns

	2-Sided Column - 2850 mm Aluminium Supplied with Top for Column (Ref. 83250 A) and Base for Column (Ref. 83251 A) in CZ (Grey) and Screw Rod (Ref. 83252 A) See Technical Data Sheet - page 31 to 33	83241	
	2-Sided Column - 3300 mm Aluminium Supplied with Top for Column (Ref. 83250 A) and Base for Column (Ref. 83251 A) in CZ (Grey) and Screw Rod (Ref. 83252 A) See Technical Data Sheet - page 31 to 33	83242	—

Minicolumns and Columns

ACCESSORIES

	MODUS 55 Adapter for Desktop Workstation, Minicolumns and Columns 4 Modules 2 Poles (for 2 modules devices)	83220	—
	90° Positioner for 2 Modules Applicable with MEC Q45 devices in Desktop Workstations, Minicolumns and Columns. Enables device assembly with 90° rotation.	45992	
	Top for Column	83250 A	
	Base for Column/Minicolumn	83251 A	CZ AL
	Top for Minicolumn	83290 A	
	Screw Rod Dimensions (mm): 1000 M16	83252 A	
	Profile for Column/Minicolumn - 2 sides - 3180 mm Supplied with 2 Covers	83253	—
	Covers for Profile Dimensions (mm): 2100	83233	

A - Accessory. | CZ - Grey; AL - Aluminium.
 Applicable with MEC Q45 devices.

MEC Q45
System

Switchgear and sockets system, which allows easy assembly and a simple choice of functions.



Control Devices	
	Ref. Colour
Single Pole Switch - 2 Modules	45011 S
Single Pole Switch - 1 Module	45010 S
Single Pole Switch with Orienting Light - 2 Modules	45012 S
Single Pole Switch with Orienting Light - 1 Module	45015 S
Single Pole Switch with Pilot Lamp - 2 Modules	45013 S
Single Pole Switch with Pilot Lamp - 1 Module	45016 S
Two-pole Switch - 2 Modules	45021 S
Two-pole Switch - 1 Module	45020 S
Two-pole Switch with Pilot Lamp - 2 Modules	45023 S
Two-pole Switch with Pilot Lamp - 1 Module	45026 S
One Circuit Digital Time Switch - 2 Modules	45041 S
Two Circuits Digital Time Switch - 2 Modules	45042 S
Card-System Timer Switch - 2 Modules	45033 S
Timer Switch - 2 Modules	45040 S
Two Circuits Switch - 2 Modules	45061 S
Two-way Switch - 2 Modules	45071 S
Two-way Switch - 1 Module	45070 S
Two-way Switch with Orienting Light - 2 Modules	45072 S
Two-way Switch with Orienting Light - 1 Module	45074 S
Two-way Switch with Pilot Lamp - 2 Modules	45073 S
Two-way Switch with Pilot Lamp - 1 Module	45076 S
Two-pole Two-way Switch - 2 Modules	45077 S
Intermediate Switch - 2 Modules	45051 S
Intermediate Switch - 1 Module	45050 S
Intermediate Switch with Orienting Light - 2 Modules	45052 S
Intermediate Switch with Orienting Light - 1 Module	45053 S
Rocker Push-button - 2 Modules	45151 S
Rocker Push-button - 1 Module	45161 S
Rocker Push-button (NO + NC) - 2 Modules	45150 S
Rocker Push-button (NO + NC) - 1 Module	45166 S
Rocker Push-button with Bell Symbol - 2 Modules	45177 S
Rocker Push-button with Bell Symbol - 1 Module	45167 S
Rocker Push-button with Lamp Symbol - 2 Modules	45179 S
Rocker Push-button with Lamp Symbol - 1 Module	45169 S

BR
BM PM AL

S - Semi-assembled | BR - White; BM - Matte White; PM - Matte Black; AL - Aluminium.

Control Devices		
	Ref.	Colour
Rocker Push-button with Orienting Light (250 V ~) - 2 Modules	45152 S	
Rocker Push-button with Orienting Light (250 V ~) - 1 Module	45160 S	
Rocker Push-button with Orienting Light (12 V) - 2 Modules	45162 S	
Rocker Push-button with Orienting Light (12 V) - 1 Module	45163 S	
Rocker Push-button with Independent Pilot Lamp (250 V ~) - 2 Modules	45154 S	
Rocker Push-button with Independent Pilot Lamp (250 V ~) - 1 Module	45153 S	
Rocker Push-button with Independent Pilot Lamp (12 V) - 2 Modules	45158 S	
Rocker Push-button with Independent Pilot Lamp (12 V) - 1 Module	45157 S	
Rocker Push-button with Orienting Light with Lamp Symbol - 2 Modules	45172 S	
Rocker Push-button with Orienting Light with Lamp Symbol - 1 Module	45171 S	
Double Rocker Push-button Switch - 2 Modules	45156 S	
Rocker Push-button / Two-way Switch - 2 Modules	45159 S	
Electronic Very Low Tension 4-Gang Push-button - 2 Modules	45164 S	
Rotary Switch - 2 Modules	45302 S	
Rotary Two-way Switch - 2 Modules	45301 S	BR BM PM AL
Key Lock Two-way Switch - 2 Modules	45352 S	
Key Lock Push-button Switch - 2 Modules	45351 S	
Two-way Pull Cord Switch - 2 Modules	45092 S	
Push-button Pull Cord Switch (NO + NC) - 2 Modules	45090 S	
Electric Shutters Switch - 2 Modules	45293 S	
Electric Shutters Switch with Mechanical Blockage - 2 Modules	45295 S	
Double Push-button for Electric Shutters - 2 Modules	45281 S	
Double Push-button Switch for Electric Shutters Control for Multiple Points - 2 Modules	45283 S	
Rotary Two-way Switch for Electric Shutters - 2 Modules	45305 S	
Rotary Push-Button for Electric Shutters - 2 Modules	45303 S	
General Control Module with IR Sensor for Electric Shutters - 2 Modules	45311 S	
Local Control Module with IR Sensor for Electric Shutters - 2 Modules	45312 S	
RLC Rotary Dimmer - 2 Modules	45216 S	
RLC Dimmer Press Switch - 2 Modules	45218 S	

Motion Detectors		
Motion Detector 1000 W - 2 Modules	45401 S	
Motion Detector 400 W - 2 Modules	45402 S	
Motion Detector - Wall Installation 1000 W - 2 Modules	45403 S	BR BM PM AL
Motion Detector - Wall Installation 400 W - 2 Modules	45404 S	

S - Semi-assembled | BR - White; BM - Matte White; PM - Matte Black; AL - Aluminium; IC - Colorless; LR - Orange; VD - Green; VM - Red.

Temperature Control		
	Ref.	Colour
Rotary Thermostat - 2 Modules	45234 S	
Multifunctional Thermostat - 2 Modules	45236 S	BR BM PM AL
Multifunctional Chronothermostat - 2 Modules	45235 S	
Floor Probe for Thermostat and Chronothermostat	81950	-

Orientation and Light Indicators		
LED Pilot Light - 1 Module	NEW 45360 S	IC VD VM LR
Light Indicator - 2 Modules	45361 S	
Double LED Pilot Light Green/Red - 1 Module	NEW 45363 S	
LED Pilot Light 2 State Green/Red - 2 Modules	NEW 45365 S	-
LED Pilot Light 2 State Green/Red - 1 Module	NEW 45364 S	
Triangular Pilot Light 2 State Green/Red - 2 Modules	NEW 45366 S	
Triangular Overdoor Light Indicator - 2 Modules	45362 S	IC VD VM LR
LED Pilot Light 2 State Green/Red - Red 12-24 V - 2 Modules	NEW 45368 S	-
LED Pilot Light 2 State Green/Red - Red 12-24 V - 1 Module	NEW 45367 S	
White Orientation Light - 2 Modules	45388 S	
White Orientation Light with Battery - 2 Modules	45389 S	BR BM PM AL
Electronic Buzzer - 1 Module	45369 S	

Data, Voice and Image Sockets		
USB Data Socket - 1 Module	45437 S	
HDMI Socket with Screw Connection - 1 Module	45435 S	
HDMI Socket with Screw Connection - 2 Modules	45436 S	
Female HD15 VGA Socket - 2 Modules	45430 S	
Female RCA Socket 3 Outputs - 1 Module	45580 S	
Module with RJ45 Connector Cat. 6A UTP - 1 Module	45440 S	
Module with RJ45 Connector Cat. 6 UTP - 1 Module	45978 S	
Module with RJ45 Connector Cat. 5e UTP - 1 Module	45975 S	BR BM PM AL
Module with RJ11 Connector Cat. 3 - 1 Module	45972 S	
Module with RJ45 Connector Cat. 6A STP - 1 Module	NEW 45987 S	
Module with RJ45 Connector Cat. 6 STP - 1 Module	45988 S	
Module with RJ45 Connector Cat. 5e STP - 1 Module	45985 S	
Module with Coaxial F-Type Connector - 1 Module	45979 S	
Module with Male IEC / F-Type Connector - 1 Module	45982 S	
Module with Female IEC / F-Type Connector - 1 Module	45983 S	
Module for 2 RJ45 Connectors - 2 Modules	45971 S	

Data, Voice and Image Sockets		
	Ref.	Colour
Module for 1 RJ45 Connector - 2 Modules	45976 S	
Module for 1 RJ45 Connector - 1 Module	45977 S	BR BM PM AL
Blind Face Plate - 1 Module	45970 S	
RJ45 Connector Cat. 6A UTP	82021	
RJ45 Connector Cat. 6 UTP	21978	
RJ45 Connector Cat. 6 UTP - Rack Assembly	82020	
RJ45 Connector Cat. 5e UTP	21975	
RJ45 Connector Cat. 6A STP	82022	-
RJ45 Connector Cat. 6 STP	21988	
RJ45 Connector Cat. 5e STP	21985	
RJ11 Connector Cat. 3	21972	
Module with Coupler for SC APC Duplex Fibre Optic Connector - 2 Modules	45448 S	
Module with Coupler for SC APC Simplex Fibre Optic Connector - 2 Modules	45447 S	BR BM PM AL
Module with Coupler for LC Duplex Fibre Optic Connector - 2 Modules	45449 S	
Protective Cover for SC APC Simplex Fibre Optic Coupler	82970	
Protective Cover for SC APC Duplex Fibre Optic Coupler	82971	-
R - TV - SAT (Star) Socket - 2 Modules	45543 S	
R - TV (Star) Socket - 2 Modules	45533 S	
R - TV - SAT (Terminal) Socket - 2 Modules	45555 S	
R - TV - SAT (Passage) Socket - 2 Modules	45565 S	BR BM PM AL
R - TV (Terminal) Socket - 2 Modules	45554 S	
R - TV (Passage) Socket - 2 Modules	45564 S	

USB Power Sockets

Double USB Charger Type A with 20° Outputs - 2 Modules	45384 S	
Double USB Charger Type A - 2 Modules	45439 S	BR BM PM AL
USB Charger Type A - 1 Module	45383 S	

Power Sockets

Safety Earth Socket (Schuko Type) with Screwless Terminals - 2 Modules	45126 S	
Safety Earth Socket (Schuko Type) with Screwless Terminals and Hinged Lid - 2 Modules	45127 S	
Safety Earth Socket (Schuko Type) - 2 Modules	45129 S	BR BM PM AL LR VD VM
Safety Earth Socket (Schuko Type) with Hinged Lid - 2 Modules	45128 S	
45° Safety Earth Socket (Schuko Type) - 2 Modules	45132 S	
45° Earth Socket (Schuko Type) - 2 Modules	45131 S	
45° Earth Socket (Schuko Type) with Blockage - 2 Modules	45136 S	VM

Power Sockets		
	Ref.	Colour
45° Earth Socket (Schuko Type) with Blockage and Signal Light - 2 Modules	45137 S	VM
Safety Earth Socket (French Type) with Screwless Terminals - 2 Modules	45476 S	
Safety Earth Socket (French Type) with Screwless Terminals and Hinged Lid - 2 Modules	45477 S	
Safety Earth Socket (French Type) - 2 Modules	45479 S	BR BM PM AL LR VD VM
Safety Earth Socket (French Type) with Hinged Lid - 2 Modules	45475 S	
45° Safety Earth Socket (French Type) - 2 Modules	45112 S	
45° Earth Socket (French Type) - 2 Modules	45111 S	
45° Earth Socket (French Type) with Blockage - 2 Modules	45116 S	
45° Earth Socket (French Type) with Blockage and Signal Light - 2 Modules	45117 S	VM
Safety Earth Socket (Euro-USA Type) - 2 Modules	45142 S	
Earth Socket (Euro-USA Type) - 2 Modules	45140 S	BR BM PM AL
Earth Socket (USA Nema Type) - 2 Modules	45144 S	
Double Safety Earth Socket (USA Type) 127 V 15 A - 3 Modules	45147 S	BR BM PM AL VM
Double Earth Socket (USA Type) 127 V 15 A - 3 Modules	45146 S	BR BM PM AL
Safety Earth Socket (Italian Type) 10 A - 1 Module	45423 S	
Safety Earth Socket (Italian Type) 16 A - 1 Module	45425 S	BR BM PM AL VM
Safety Earth Socket (Italian Type) 10 / 16 A - 1 Module	45421 S	
Safety Earth Socket (Brazilian Type) 10 A - 1 Module	45413 S	BR BM PM AL VM
Earth Socket (Brazilian Type) 10 A - 1 Module	45412 S	BR BM PM AL
Safety Earth Socket (Brazilian Type) 20 A - 1 Module	45415 S	BR BM PM AL VM
Earth Socket (Brazilian Type) 20 A - 1 Module	45414 S	BR BM PM AL
Block of Two Safety Earth Sockets (Schuko Type) - 4 Modules	45192 S	
Block of Two Earth Sockets (Schuko Type) - 4 Modules	45190 S	
Block of Three Safety Earth Sockets (Schuko Type) - 6 Modules	45196 S	
Block of Three Earth Sockets (Schuko Type) - 6 Modules	45194 S	
Block of Two Safety Earth Sockets (French Type) - 4 Modules	45193 S	BR VM
Block of Two Earth Sockets (French Type) - 4 Modules	45191 S	
Block of Three Safety Earth Sockets (French Type) - 6 Modules	45197 S	
Block of Three Earth Sockets (French Type) - 6 Modules	45195 S	

S - Semi-assembled | BR - White; BM - Matte White; PM - Matte Black; AL - Aluminium; LR - Orange; VD - Green; VM - Red.

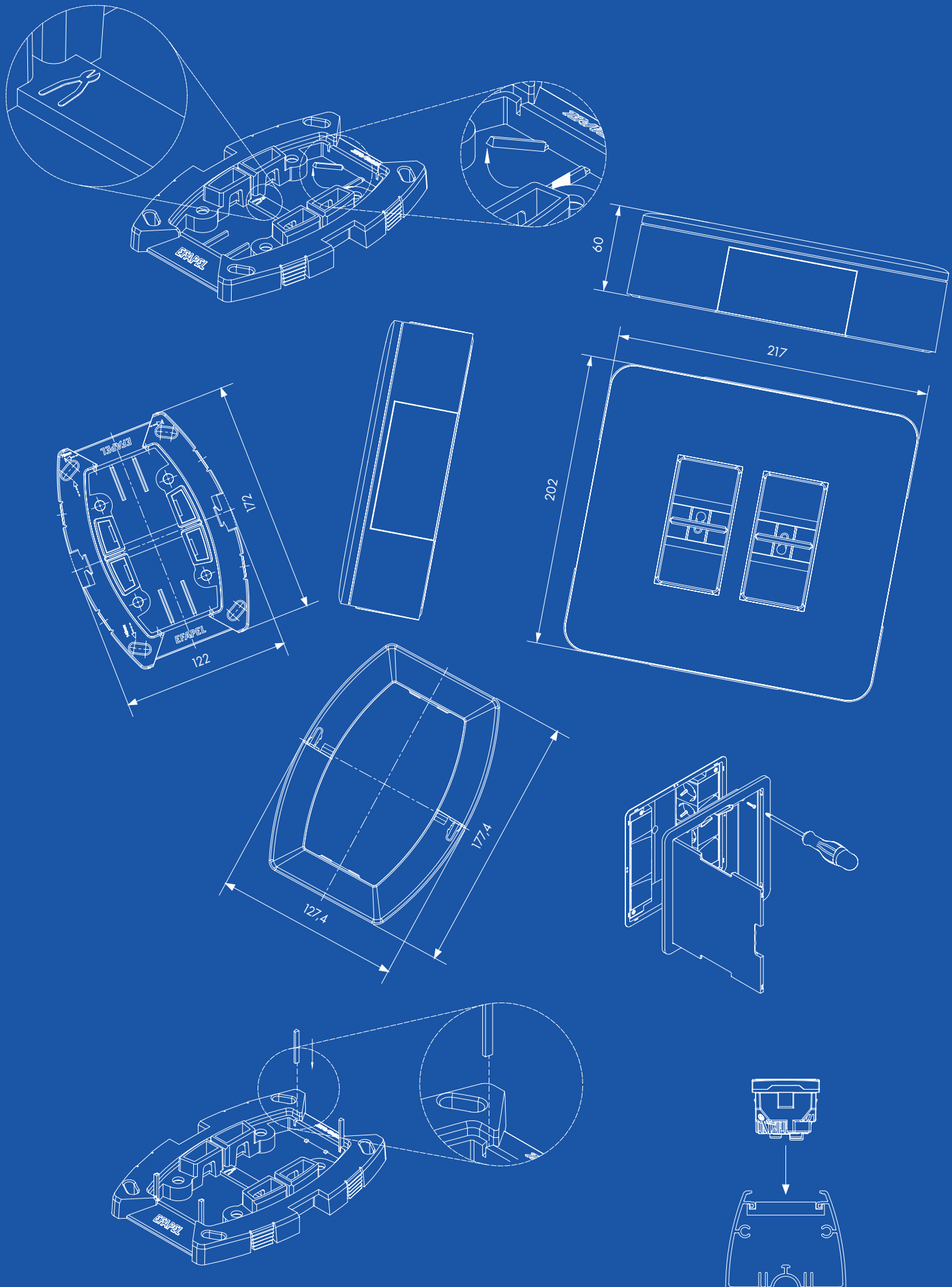

Floor Box - 4 Modules

Description

Ref. 83002 C



Box for concrete installation through Flush Mounting Boxes (Ref. 83052) and on technical floor through claws.
Available in colours **CZ** - Grey, **AT** - Anthracite and **BR** - White.
Applicable with **MEC Q45** devices.

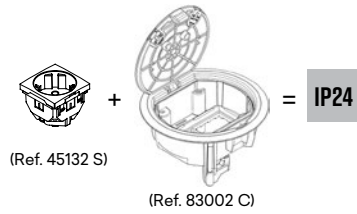

Mounting Diagram



- 1 - Floor Box Cover - 4 Modules.
- 2 - Self-tapping screws for plastic claw.
- 3 - Floor Box - 4 Modules (Ref. 83002 C).
- 4 - Self-tapping screws for plastic claw.
- 5 - Flush Mounting Box for Floor Box - 4 Modules (Ref. 83052).
- 6 - Plastic claw for Floor Box.

Dimensions (mm)

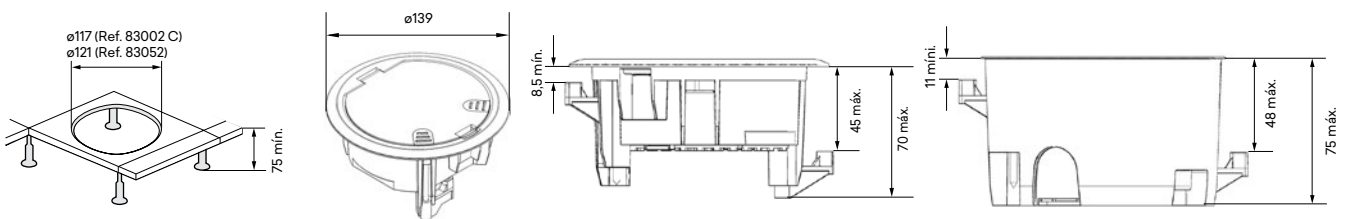

Floor Boxes - 8, 12, 16, 24 Modules

Description



IK10

Ref. 83004 C | 83006 C | 83008 C | 83012 C

Box for concrete installation through Flush Mounting Boxes and on technical floor through claws.

Available in colours **CZ** - Grey, **AT** - Anthracite.

Available with Inox Cover (Ref. 83008 C) in colours: **ZI** - Grey/Inox, **AI** - Anthracite/Inox.

Applicable with MEC **Q45** devices.

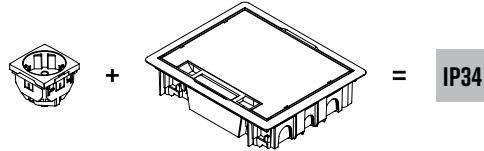

Installation in Technical Floor

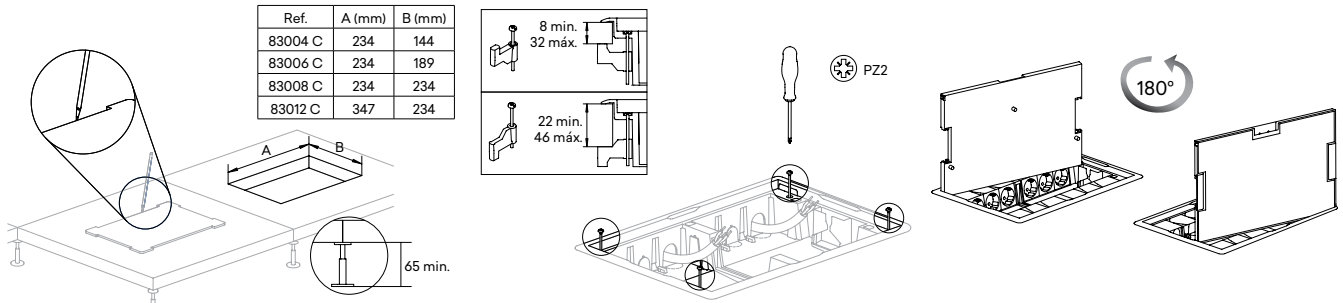

Installation in Concrete with Flush Mounting Box

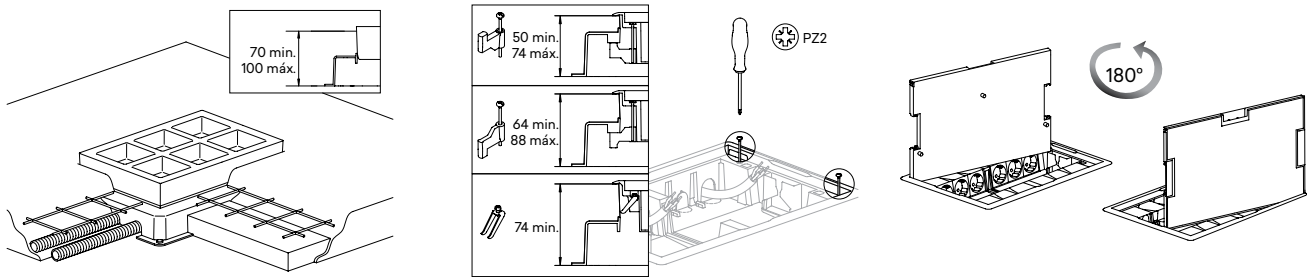

Dimensions (mm)

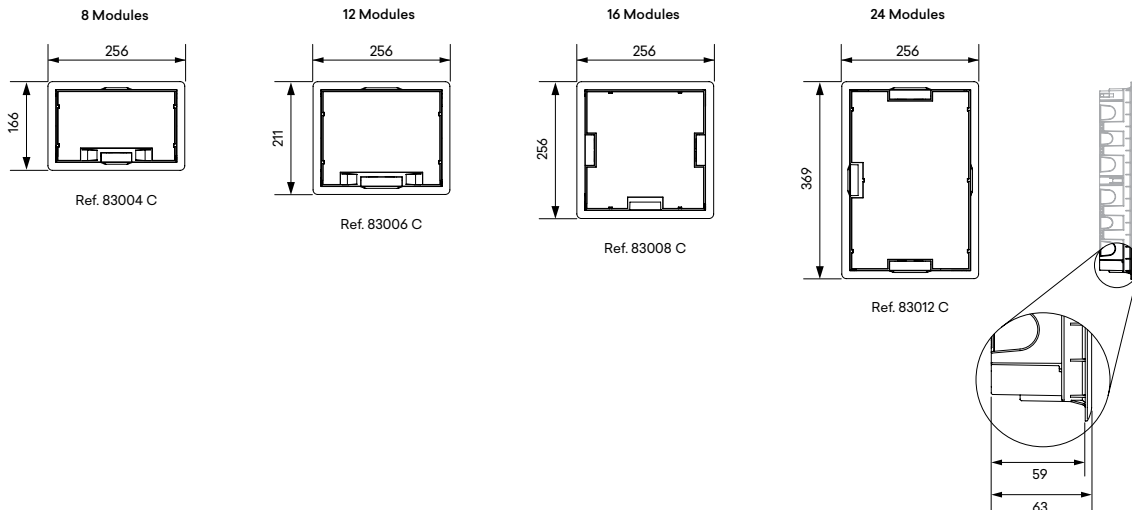

EN 60670-1; EN 60670-23 Standards

Section 7	Classification	4, 8, 12, 16 and 24 Modules
7.1	Nature of the material	Insulating
7.2	Type of installation	Embedded, semi-embedded or integrated into combustible walls, ceilings or flooring
		Embedded, semi-embedded or integrated into hollow or partition walls (false ceilings, walls, floors), furniture
		For tunnel type installation during the concrete projection step (7.6)
		Treatment of flooring: in boxes and enclosures for installation in floorings submitted to dry treatment
7.3	Types of inputs (outputs)	With inputs for plain or corrugated pipes
7.4	Means for fixing cables and pipes	Without fixing
7.5	Minimum and maximum temperatures during the installation	-25 °C to +60 °C
7.6	Maximum temperature during the concrete filling step	90 °C
7.8	Means for fixing the devices to the boxes	Boxes designed to enable other means of fixing
7.101	Type of movable cover	Enclosure with removable cover

Tests - EN 50085-1; EN 50085-2-2 Standards

Section 10	Classification	4 Modules	8, 12, 16 and 24 Modules
10.3.2	Impact test of mechanical resistance for installation and application	2 J	5 J
10.3.2	EN 50102 - IK Test	IK08	IK10
10.5.1	IEC 60884-1 – NP 1260 Fixation of low voltage devices - resistance to extraction test	Declared Force of Extraction: 90 N 1,5 x 90 = 135 N	
10.5.103	Resistance to vertical load applied through a small surface area	750 N	
10.5.104	Resistance to vertical load applied through a large surface area	3000 N	

Workstation Surface Mounting - 2x4 + 4x4 Modules

Description



Ref. 83410 S

Workstation for Surface Mounting in masonry.
 Available in colours BR - White, BM - Matte White, PM - Matte Black, AL - Aluminium.
 Applicable with MEC Q45 devices.

Installation

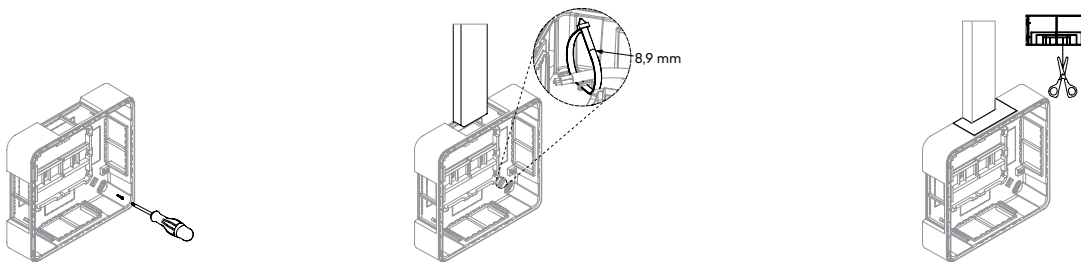

Installation with Mec Q45 Devices

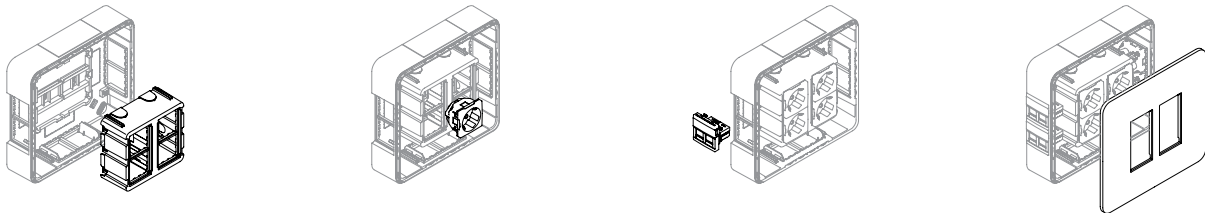

Installation with MODUS 55

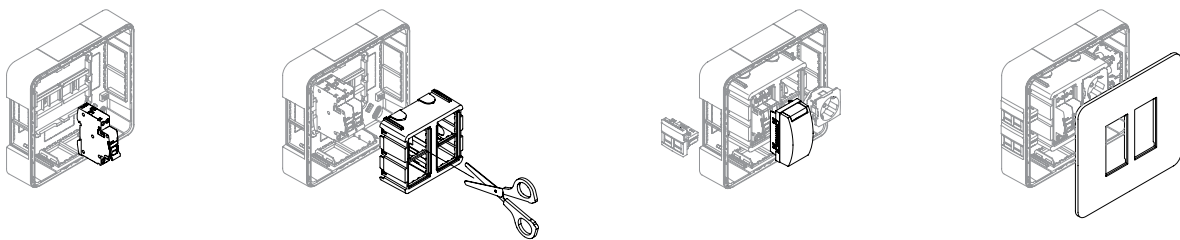

Dimensions (mm)

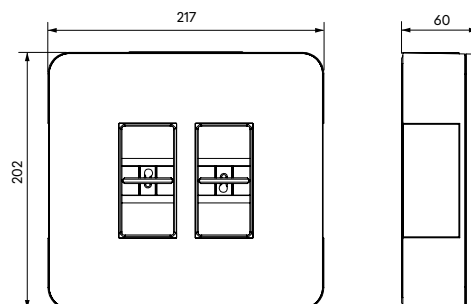

Workstations Surface Mounting 2X4 | 3x4 | 4X4 Modules

Description



Ref. 83411 S | 83412 S | 83413 S

Workstation for Surface Mounting in masonry.
 Available in colours BR - White, BM - Matte White, PM - Matte Black, AL - Aluminium.
 Applicable with MEC Q45 devices.

Installation

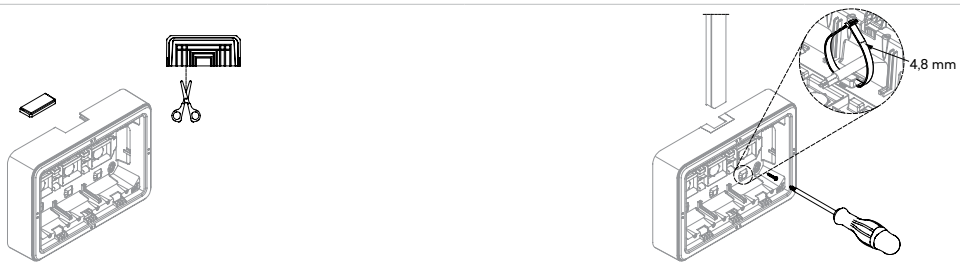

Installation with Mec Q45 Devices

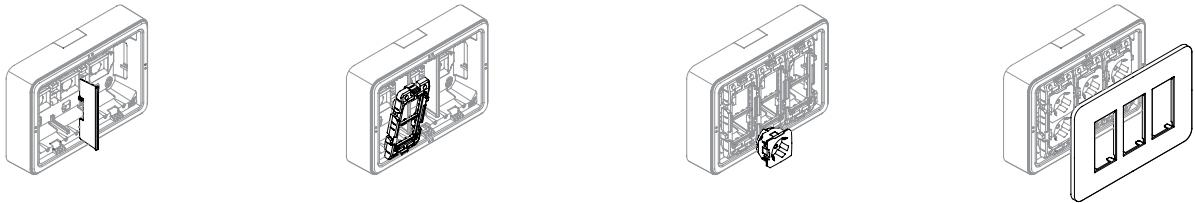

Installation with MODUS 55

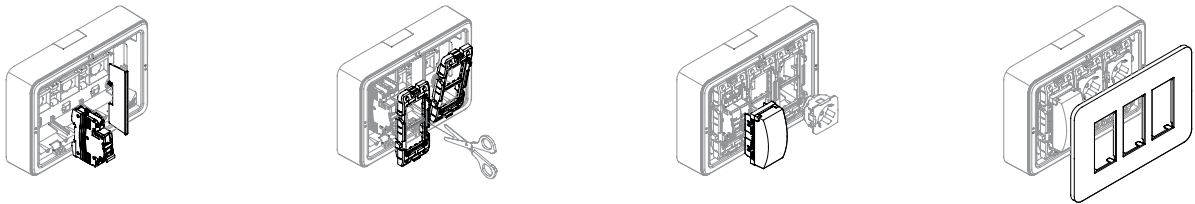

Dimensions (mm)

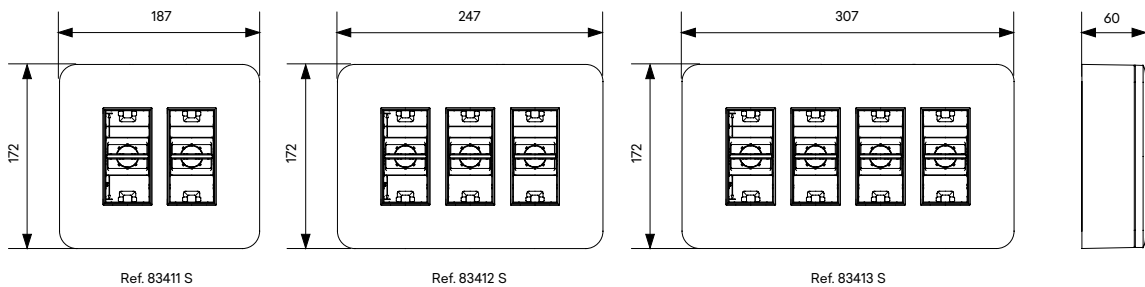

EN 60670-1; EN 60670-24 Standards

Section 7	Classification	Workstations Surface Mounting
7.1	Nature of the material	Insulating
7.2	Type of installation	Surface mounting on: - non-combustible walls, ceilings or furniture; - combustible walls, ceilings or furniture.
7.3	Types of inputs (outputs)	Without inputs Input openings are made during installation
7.4	Means for fixing cables and pipes	With cable retention
7.5	Minimum and maximum temperatures during the installation	-5 °C to +60 °C
7.8	Means for fixing the devices to the boxes	Boxes designed to enable other means of fixing
7.102	Enclosure	Enclosure PD (for predetermined equipment)
	Degree of protection of the enclosure: IP3XC Impact test: IK07	
	The maximum permissible load within the enclosure 2x4 + 4x4 is 1,4 Kg (The maximum load was verified by the maximum weight of the MCB applied and with an increase of 1.5)	
	The maximum permissible load within the enclosure 2x4 is 1,4 Kg (The maximum load was verified by the maximum weight of the MCB applied and with an increase of 1.5)	
	The maximum permissible load within the enclosure 3x4 is 2,1 Kg (The maximum load was verified by the maximum weight of the MCB applied and with an increase of 1.5)	
	The maximum permissible load within the enclosure 4x4 is 2,8 Kg (The maximum load was verified by the maximum weight of the MCB applied and with an increase of 1.5)	
	Rated Voltage - 250 V ~ Rated Current - 63 A	

Information

Annex BB		
BB3	Devices to be integrated in the enclosure by the installer	The devices integrated in the enclosure by the installer shall comply with their applicable product standards, (e.g. 1 MCB shall comply with IEC 60898-1, 1 RCCB shall comply with IEC 61008-1 and 1 RCBO shall comply with IEC 61009-1). The sockets shall comply with IEC 60884-1 and have safety shutters (Ref. 45132 S, 45112 S). Compatible with devices 45x45 - MEC Q45 .
BB5	Connections	Terminals must be used in accordance with the standard EN 60998-2-1.
BB6	Protection against electric shock	Active parts shall remain inaccessible after devices are installed in the enclosure. Devices mounted in the enclosure shall have a minimum IP degree of IP3X.
BB8	Wiring	The installation must ensure that the internal wiring shall be such that minimum creepage distances between live parts and metallic accessible or non-accessible parts are not less than 3 mm. The cross-sections of conductors shall be in accordance with the wiring installation rules

IEC 60884-1; NP 1260-1 Standards

Section 9		
9.4	Fixing of low voltage devices	90 N x 1,5 = 135 N

Workstations Flush Mounting 2x4 | 3x4 | 4x4 Modules

Description



Ref. 83401 S | 83402 S | 83403 S

Workstation for installation in masonry or in hollow walls by using claws.
 Available in colours BR - White, BM - Matte White, PM - Matte Black, AL - Aluminium.
 Applicable with MEC Q45 devices.

Installation in Masonry

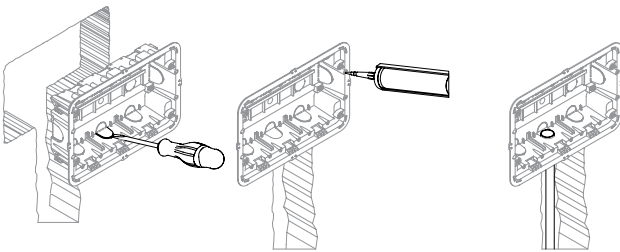

Installation in Hollow Walls

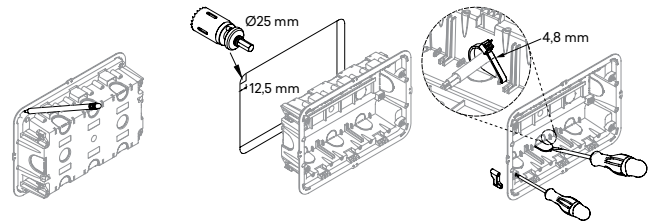

Installation with Mec Q45 Devices

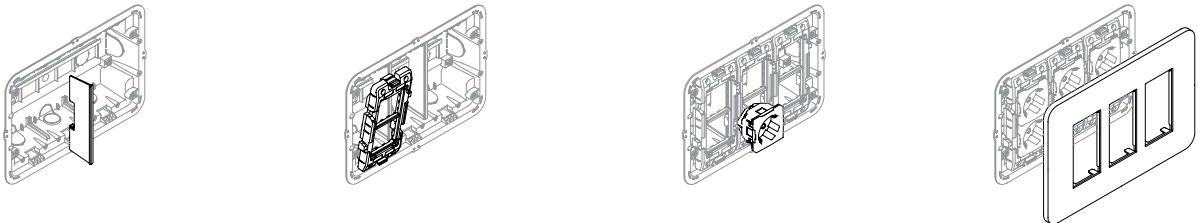

Installation with MODUS 55

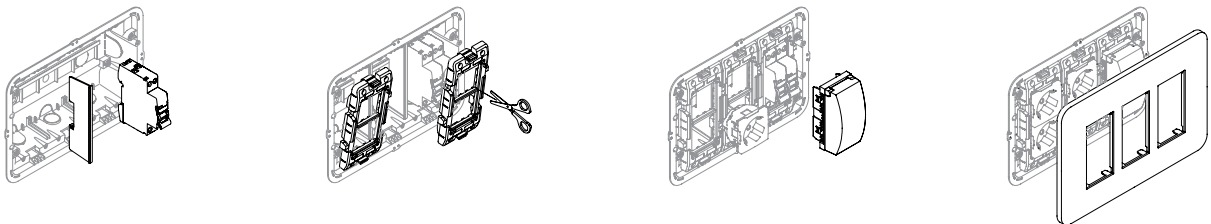

Dimensions (mm)

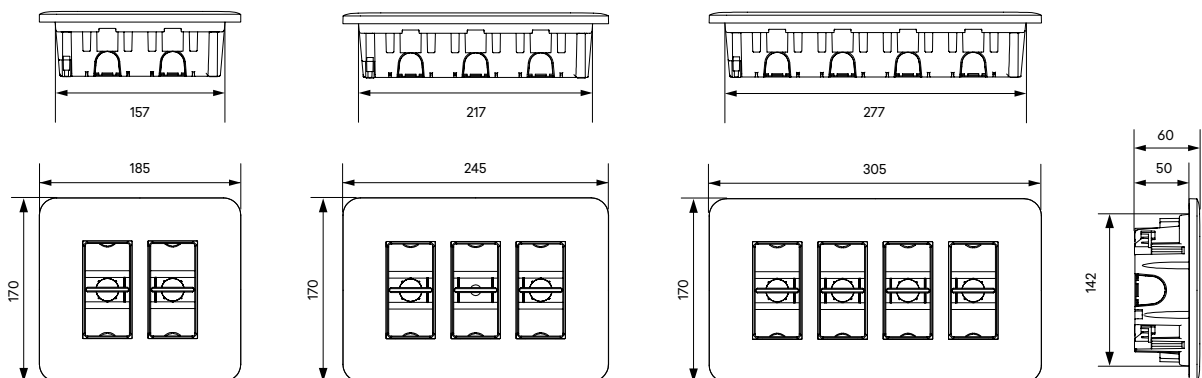

EN 60670-1; EN 60670-24 Standards

Section 7	Classification	Workstations Flush Mounting
7.1	Nature of the material	Insulating
7.2	Type of installation	Embedded, semi-embedded or integrated: non-combustible walls or ceilings; combustible walls or ceilings; hollow or partition walls (false ceilings, walls), furniture.
7.3	Types of inputs (outputs)	With inputs for plain or corrugated pipes
7.4	Means for fixing cables and pipes	With cable retention
7.5	Minimum and maximum temperatures during the installation	-5 °C to +60 °C
7.7	Boxes or enclosures for hollow or partition walls, classified according to 7.2.1.3	Degree of protection of the enclosure: IP3XC
7.8	Means for fixing the devices to the boxes	Boxes designed to enable other means of fixing
7.102	Enclosure	Enclosure PD (for predetermined equipment)
	Resistance of the enclosure embedded area (back box) to the glow-wire test a 850 °C	
	Impact test - IK07	
	The maximum permissible load within the enclosure 2x4 is 1,4 Kg (The maximum load was verified by the maximum weight of the MCB applied and with an increase of 1.5)	
	The maximum permissible load within the enclosure 3x4 is 2,1 Kg (The maximum load was verified by the maximum weight of the MCB applied and with an increase of 1.5)	
	The maximum permissible load within the enclosure 4x4 is 2,8 Kg (The maximum load was verified by the maximum weight of the MCB applied and with an increase of 1.5)	
	Rated Voltage - 250 V ~ Rated Current - 63 A	

Information

Annex BB		
BB3	Devices to be integrated in the enclosure by the installer	The devices integrated in the enclosure by the installer shall comply with their applicable product standards, (e.g. 1 MCB shall comply with IEC 60898-1, 1 RCCB shall comply with IEC 61008-1 and 1 RCBO shall comply with IEC 61009-1). The sockets shall comply with IEC 60884-1 and have safety shutters (Ref. 45132 S, 45112 S). Compatible with devices 45x45 - MEC Q45 .
BB5	Connections	Terminals must be used in accordance with the standard EN 60998-2-1.
BB6	Protection against electric shock	Active parts shall remain inaccessible after devices are installed in the enclosure. Devices mounted in the enclosure shall have a minimum IP degree of IP3X.
BB8	Wiring	The installation must ensure that the internal wiring shall be such that minimum creepage distances between live parts and metallic accessible or non-accessible parts are not less than 3 mm. The cross-sections of conductors shall be in accordance with the wiring installation rules

EN 50085-1 Standard

Section 9		
9.4	Screwed mechanical connections	0,8 Nm

IEC 60884-1; NP 1260-1 Standards

Section 9		
9.4	Fixing of low voltage devices	90 N x 1,5 = 135 N

Workstation Flush Mounting with Door 2x8 Modules

Description



Ref. 83404 S

Workstation for installation in masonry or in hollow walls by using claws.
 Available in colours BR - White.
 Applicable with MEC Q45 devices.

Installation in Masonry

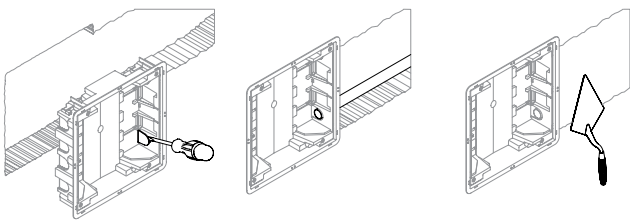

Installation in Hollow Walls

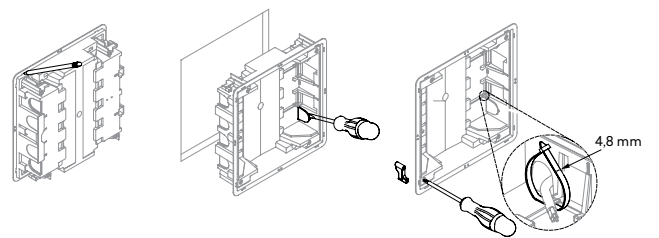

Installation with Mec Q45 Devices

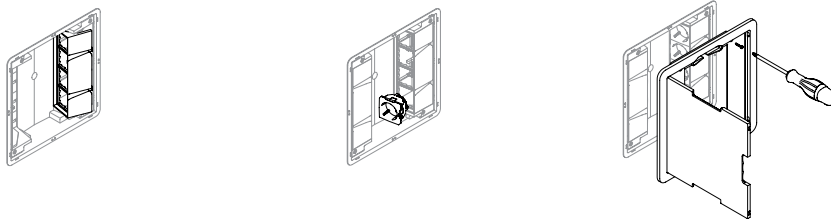

Installation with MODUS 55

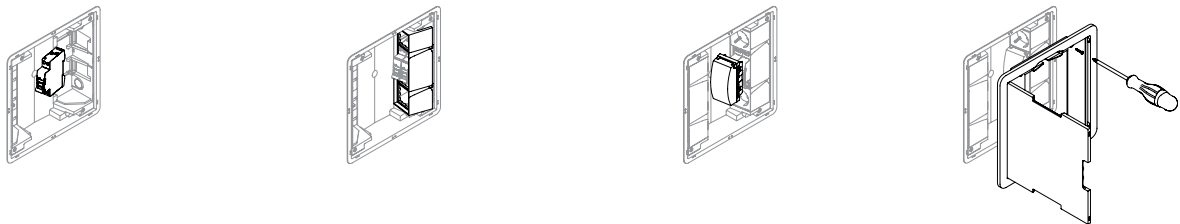

Dimensions (mm)

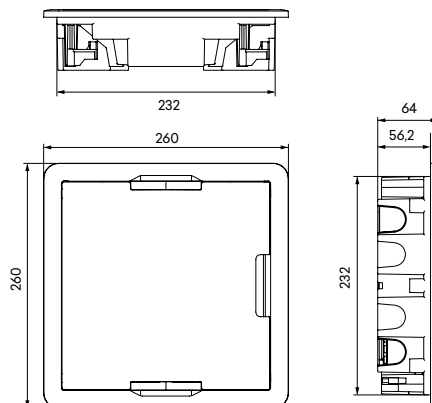

EN 60670-1; EN 60670-24 Standards

Section 7	Classification	Workstation Flush Mounting with Door
7.1	Nature of the material	Insulating
7.2	Type of installation	Embedded, semi-embedded or integrated: non-combustible walls or ceilings; combustible walls or ceilings; hollow or partition walls (false ceilings, walls), furniture..
7.3	Types of inputs (outputs)	With inputs for plain or corrugated pipes
7.4	Means for fixing cables and pipes	With cable retention
7.5	Minimum and maximum temperatures during the installation	-5 °C to +60 °C
7.7	Boxes or enclosures for hollow or partition walls, classified according to 7.2.1.3	Degree of protection of the enclosure: IP3XC
7.8	Means for fixing the devices to the boxes	Boxes designed to enable other means of fixing
7.102	Enclosure	Enclosure PD (for predetermined equipment)
	Resistance of the enclosure embedded area (back box) to the glow-wire test a 850 °C	
	Impact test - IK07	
	The maximum permissible load within the enclosure is 1,4 Kg (The maximum load was verified by the maximum weight of the MCB applied and with an increase of 1.5)	
	Rated Voltage - 250 V ~ Rated Current - 63 A	

Information

Annex BB		
BB3	Devices to be integrated in the enclosure by the installer	The devices integrated in the enclosure by the installer shall comply with their applicable product standards, (e.g. 1 MCB shall comply with IEC 60898-1, 1 RCCB shall comply with IEC 61008-1 and 1 RCBO shall comply with IEC 61009-1). The sockets shall comply with IEC 60884-1 and have safety shutters (Ref. 45132 S, 45112 S). Compatible with devices 45x45 - MEC Q45 .
BB5	Connections	Terminals must be used in accordance with the standard EN 60998-2-1.
BB6	Protection against electric shock	Active parts shall remain inaccessible after devices are installed in the enclosure. Devices mounted in the enclosure shall have a minimum IP degree of IP3X.
BB8	Wiring	The installation must ensure that the internal wiring shall be such that minimum creepage distances between live parts and metallic accessible or non-accessible parts are not less than 3 mm. The cross-sections of conductors shall be in accordance with the wiring installation rules

EN 50085-1 Standard

Section 9		
9.4	Screwed mechanical connections	0,8 Nm

IEC 60884-1; NP 1260 Standard

Section 9		
9.4	Fixing of low voltage devices	90 N x 1,5 = 135 N

Desktop Workstations

Description



IK09

Ref. 83201 S | 83202 S

It can be attached to a desk, wall, DIN rail or to another location.
Applicable with **MEC Q45** devices.

Mounting Diagram

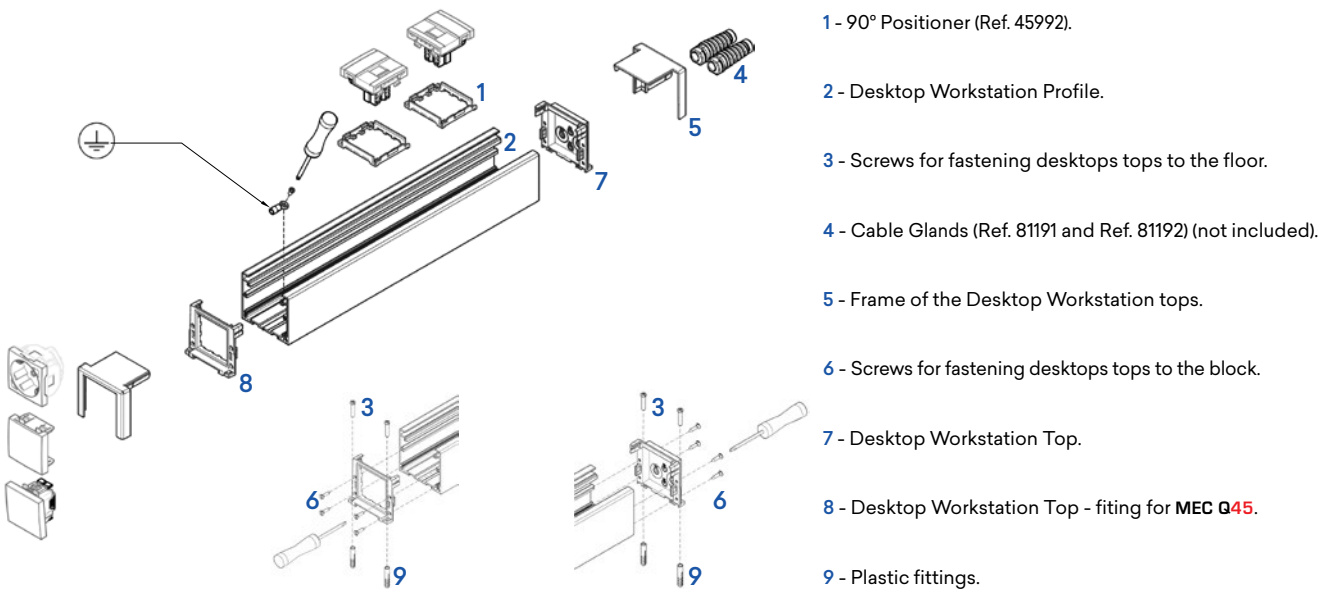

Ref. 83220 - Mounting Diagram

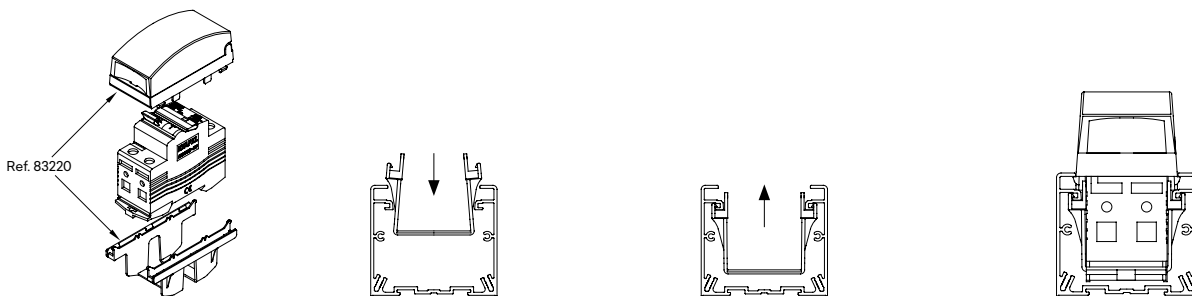

Ref. 45992 - Mounting Diagram

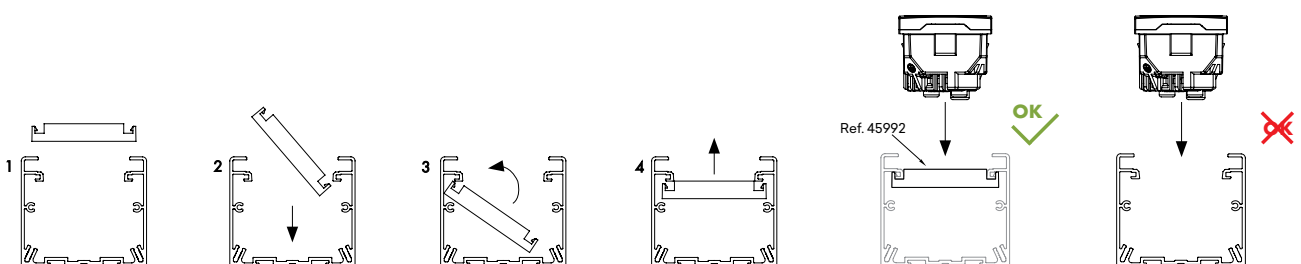

Desktop Workstations

Ref. 83234 - Mounting Diagram

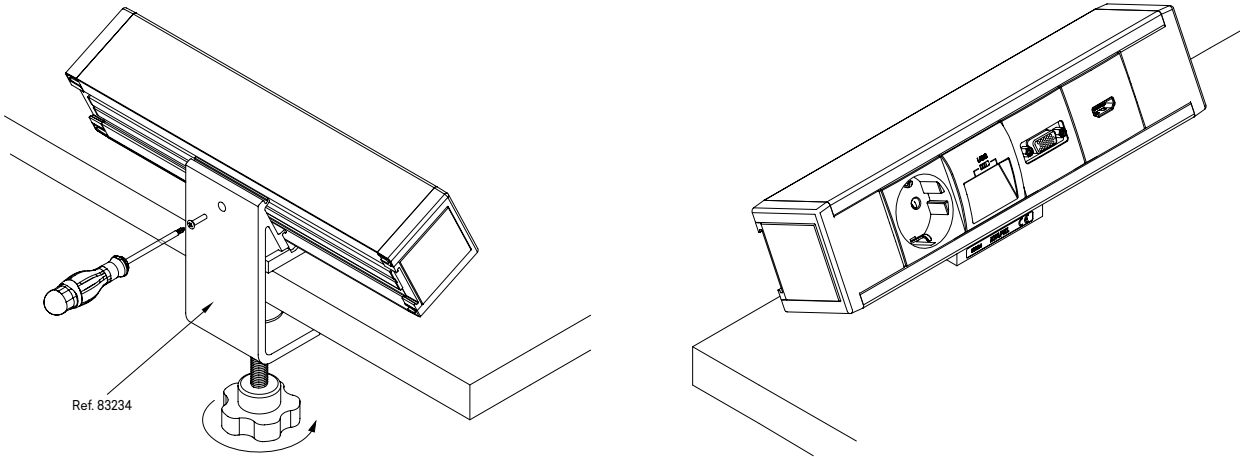

Dimensions (mm)

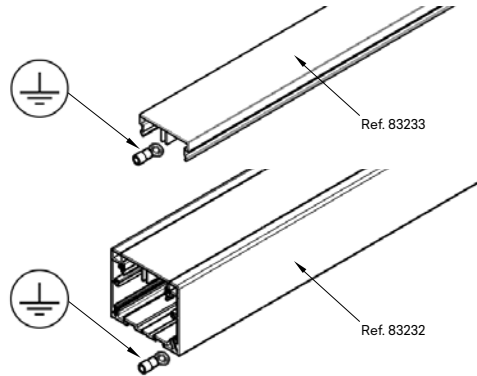
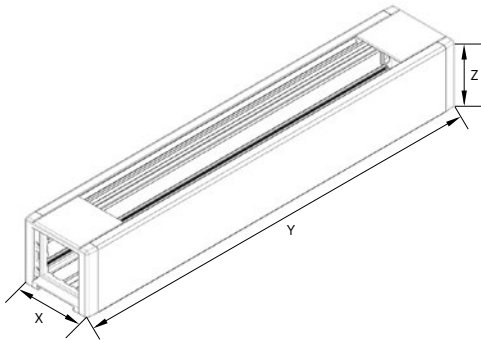

	X	Y	Z
Ref. 83201 S (8 + 2 Modules)	62,0 mm	269,5 mm	54,5 mm
Ref. 83202 S (12 + 2 Modules)	62,0 mm	360,5 mm	54,5 mm

Ref. 83233	2100 mm
Ref. 83232	2100 mm

Section

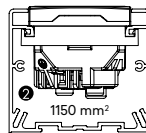
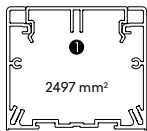

Refs. 83232, 83201 S, 83202 S + 45132 S

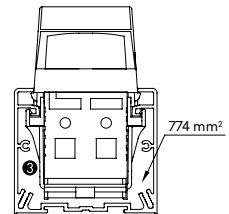

Refs. 83232, 83201 S, 83202 S + 55316 6BY

Maximum Diameter Available (mm)

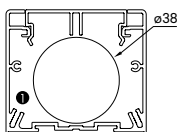

Refs. 83232, 83201 S, 83202 S + 45132 S

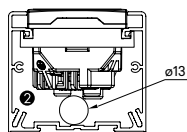

Refs. 83232, 83201 S, 83202 S + 55316 6BY

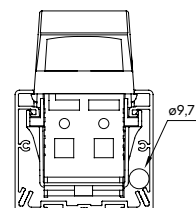

Profile Selection

Ref.	Profile Characteristics			Insulated Cables Capacity					
	Section	Internal Section (S)	Available Section (Su)	Max ø Available (mm)	Max. Nr. Conductors H07 V-U				
		(mm ²)	(S/1,4) (mm ²)		1,5mm ²	2,5mm ²	4mm ²	6mm ²	
Profile and Desktop Workstations	83232 83201 S 83202 S	①	2497	1784	38	223	149	119	89
Profile and Desktop Workstations with MEC Q45 Soket	83232 83201 S 83202 S + 45132 S	②	1150	821	13	103	68	55	41
Profile and Desktop Workstations with RCBO	83232 83201 S 83202 S + 55316 6BY	③	774	552	9,7	69	45	36	27

EN 50085-2-1 STANDARD

Section 6	Classification	Desktop Workstations
6.2	Resistance to impact for installation and application	10 J
6.3	Minimum storage and transport temperature	-45 °C
6.3	Minimum installation and operation temperature	-25 °C
6.3	Maximum operation temperature	60 °C
6.4	Resistance to flame propagation	Non-flame propagating
6.5	Electrical continuity	With electrical continuity $1,5 \times 10^{-4} \Omega/m$
6.6	Electrical insulation	Without electrical insulation
6.7	Protection degree provided by the enclosure	IP30
6.8	Protection against corrosive or polluting substances	Medium protection outside and inside
6.9	Access system to the retention of the cover	The cover can only be removed with a tool
6.10	Electrical protective separation	Without electrical protective partition (divider)
6.101	Installation positions	Surface mounting, fixed to a wall or ceiling
6.102	Prevention of contact between liquids and insulated conductors and live parts in case of assembly on skirting and on wet floor	Not declared
6.103	Type	3 (Installation)
	Rated Voltage	500 V ~

Minicolumns

Description



Ref. 83282 | 83281 | 83283

Enables the placement of all the interconnection points (energy and communication) next to the workstation.
Applicable with MEC Q45 devices.

Mounting Diagram

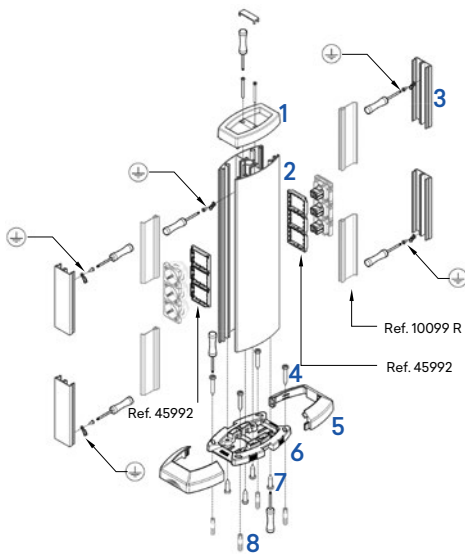

- 1 - Top for Minicolumn (Ref. 83290 A).
- 2 - Minicolumn Profile (Ref. 83253).
- 3 - Cover of Minicolumn (Ref. 83233).
- 4 - Screws to fix base of Minicolumn to ground.
- 5 - Frame of Minicolumn.
- 6 - Base of Minicolumn (Ref. 83251 A).
- 7 - Screws to fix Minicolumn to base.
- 8 - Plastic fittings.

Ref. 83251 A - Mounting Diagram

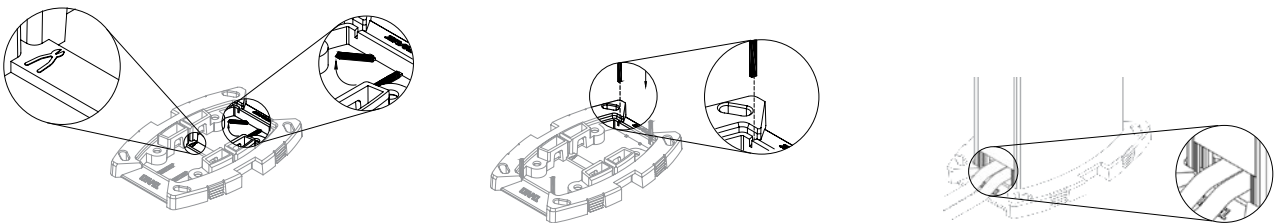

Ref. 83220 - Mounting Diagram

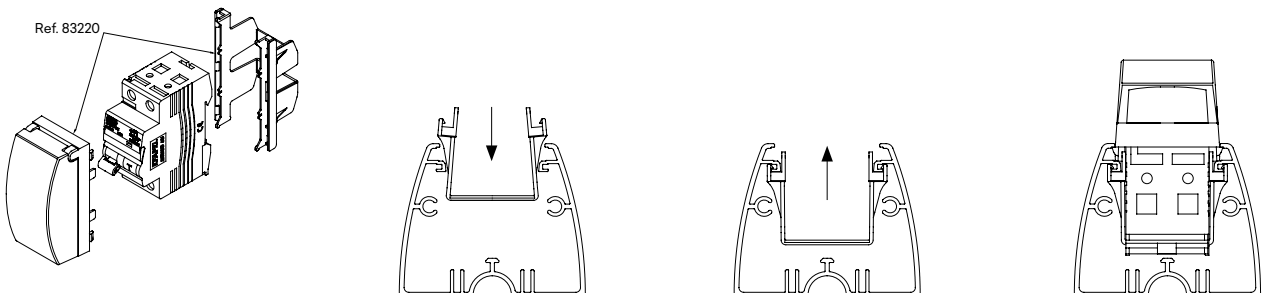

Minicolumns

Dimensions (mm)

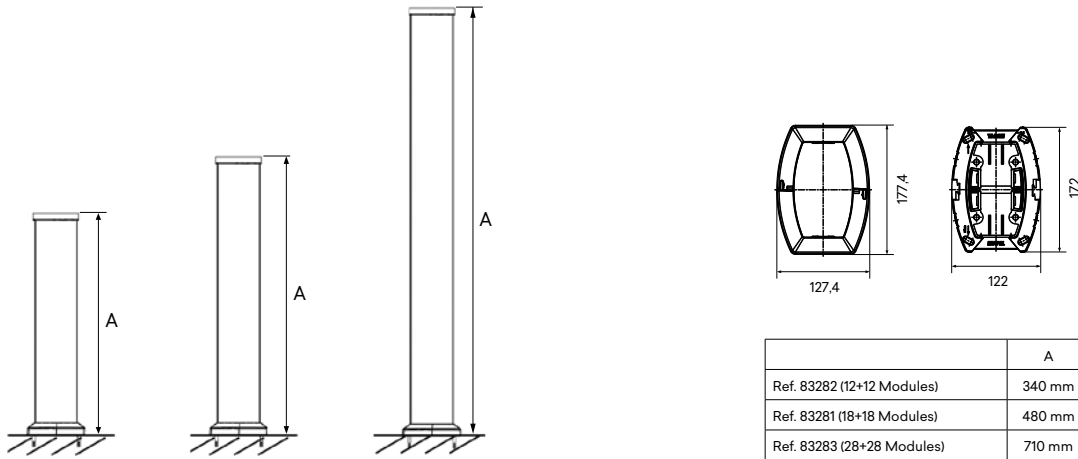

Ref. 45992 - Mounting Diagram

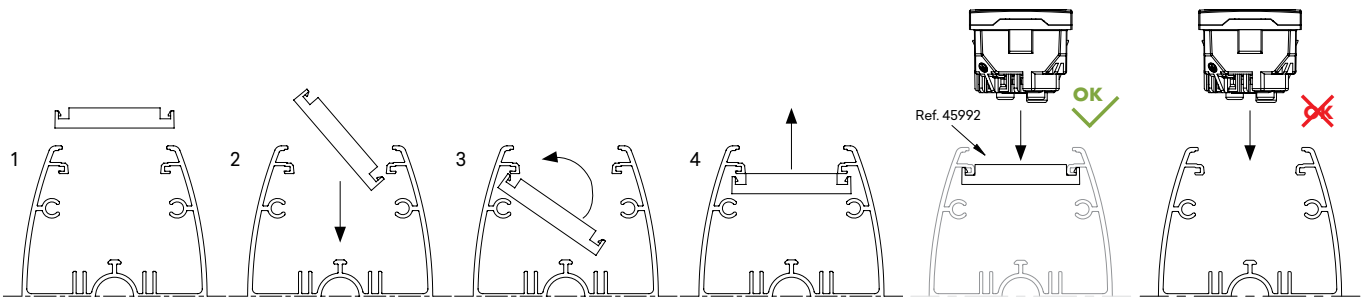

Section

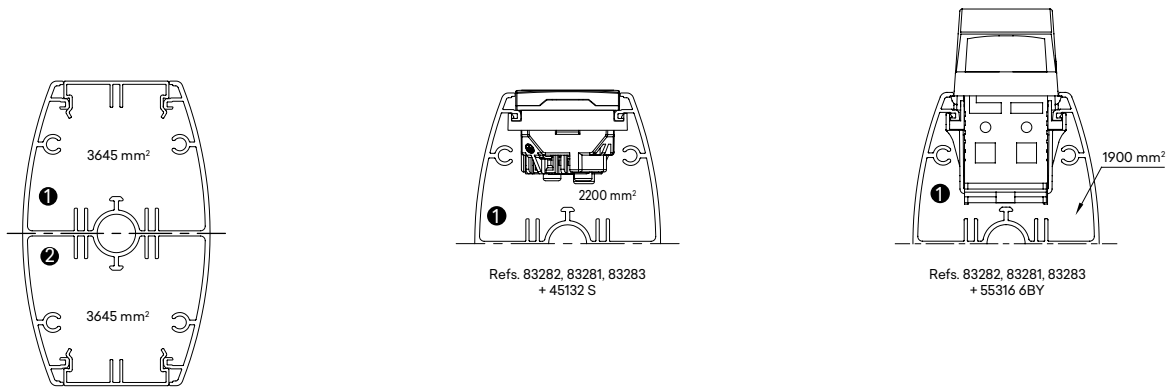

Maximum Diameter Available (mm)

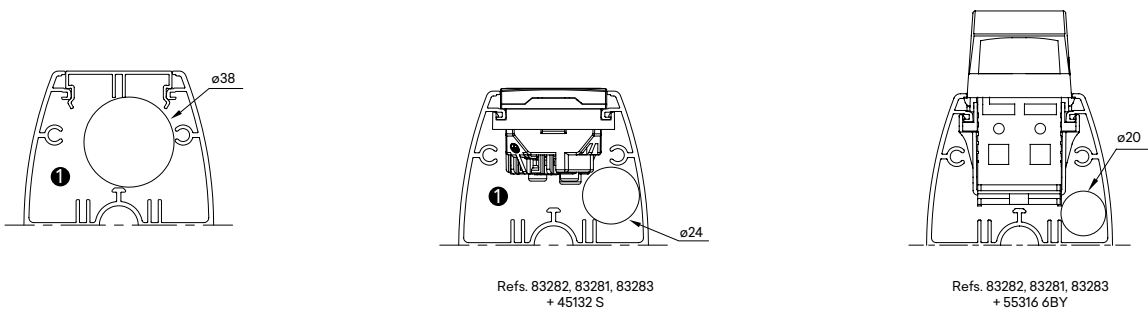

Columns

Description



Ref. 83241 | 83242

Allows the power supply and the passage of cables between the ceiling and the floor.
Applicable with MEC Q45 devices.

Mounting Diagram

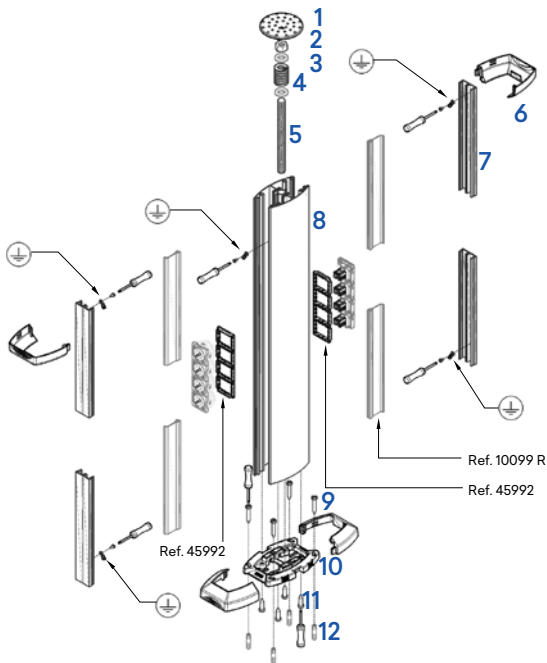

- 1 - Ceiling fixing device.
- 2 - Hexagon Nut M16x13.
- 3 - Ring M16x13.
- 4 - Spring.
- 5 - Screw Rod M16x1000 (Ref. 83252 A).
- 6 - Column Frame.
- 7 - Column Cover (Ref. 83233).
- 8 - Column Profile (Ref. 83253).
- 9 - Screws to fix the base of the Column to the ground.
- 10 - Column Base (Ref. 83251 A).
- 11 - Screws to fix the Column to the base.
- 12 - Plastic fittings.

Ref. 83251 A - Mounting Diagram

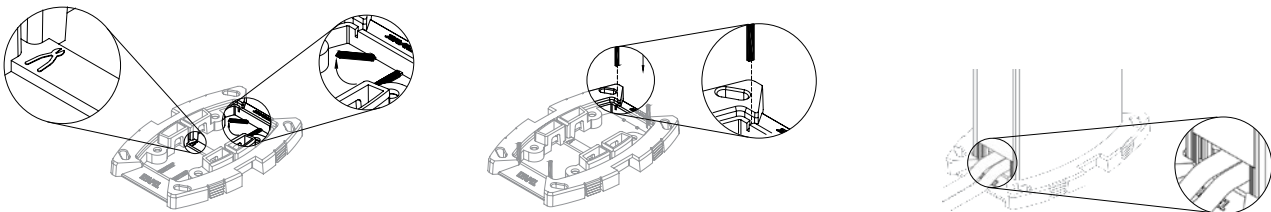

Ref. 83220 - Mounting Diagram

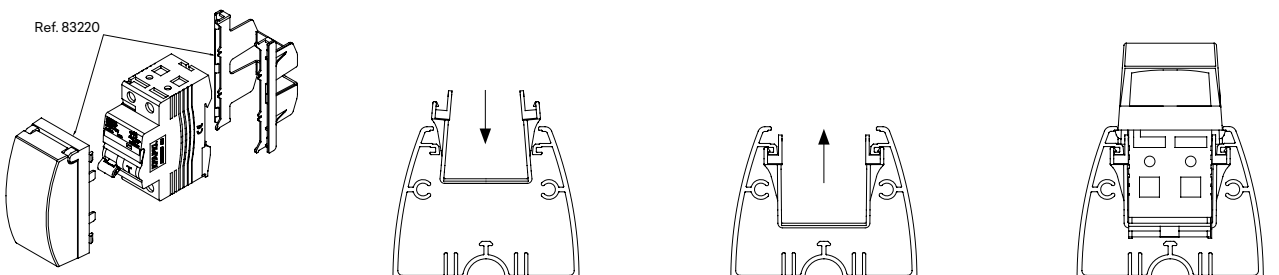

Columns

Dimensions (mm)

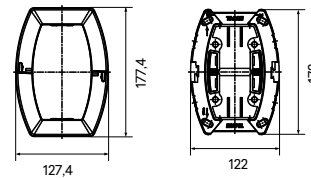
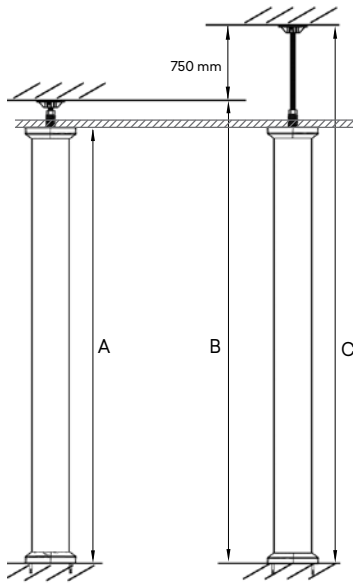

	A	B	C
Ref. 83241	2730 mm	2850 mm	3600 mm
Ref. 83242	3180 mm	3300 mm	4050 mm

Ref. 45992 - Mounting Diagram

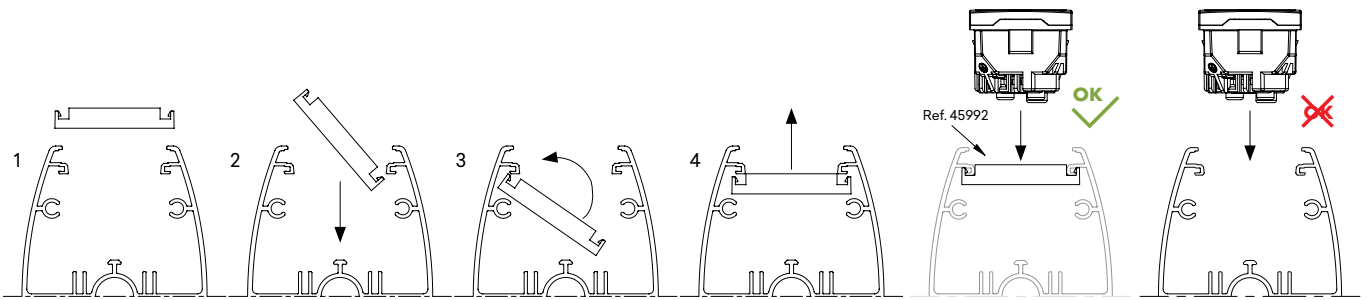

Section

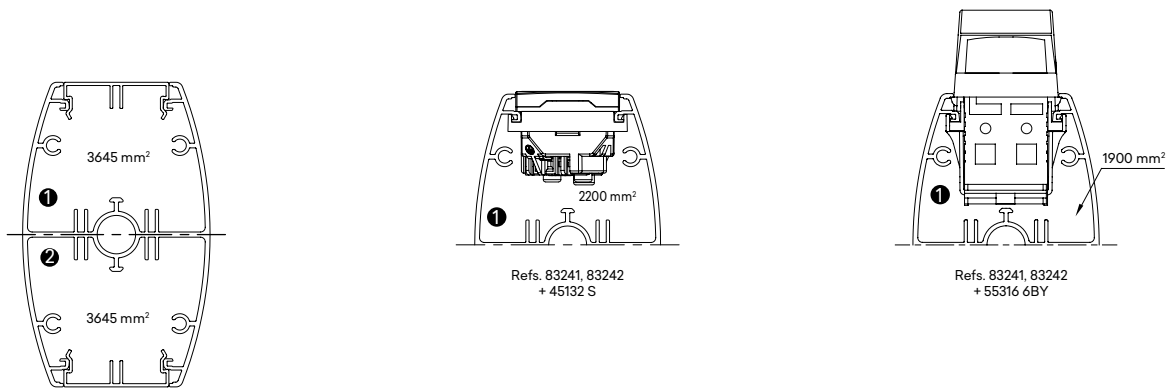

Maximum Diameter Available (mm)

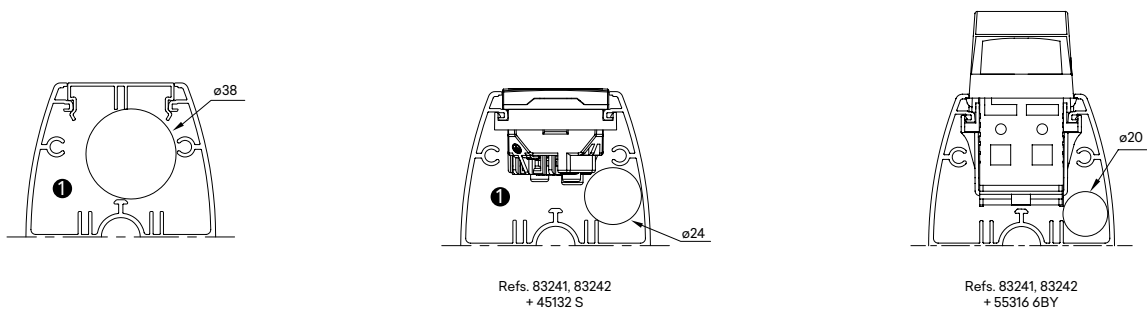

Minicolumns and Columns

Profile Selection

Ref.	Profile Characteristics			Insulated Cables Capacity				
	Section	Internal Section (S)	Available Section (Su)	Max ø Available (mm)	Max. Nr. Conductors H07 V-U			
		(mm ²)	(S/1,4) (mm ²)		1,5mm ²	2,5mm ²	4mm ²	6mm ²
Minicolumns and Columns 83282 83281 83283 83241 83242	①	3645	2604	38	325	217	174	130
	②							
Minicolumns and Columns with MEC Q45 Socket 83282 83281 83283 83241 83242 + 45132 S	①	2200	1571	24	196	131	105	79
	②							
Minicolumns and Columns with RCBO 83282 83281 83283 83241 83242 + 55316 6BY	①	1900	1357	20	170	113	90	67
	②							

EN 50085-2-1 Standard

Section 6	Classification	Minicolumns and Columns
6.2	Resistance to impact for installation and application	10 J
6.3	Minimum storage and transport temperature	-45 °C
6.3	Minimum installation and operation temperature	-25 °C
6.3	Maximum operation temperature	60 °C
6.4	Resistance to flame propagation	Non-flame propagating
6.5	Electrical continuity	With electrical continuity 5x10 ⁻⁵ Ω/m
6.6	Electrical insulation	Without electrical insulation
6.7	Protection degree provided by the enclosure	IP31
6.8	Protection against corrosive or polluting substances	Medium protection outside and inside
6.9	Access system to the retention of the cover	The cover can only be removed with a tool
6.10	Electrical protective separation	Without electrical protective partition (divider)
6.101	Type of floor	Dry floor
6.102	1000 N	
6.103	5000 N	
	Rated Voltage	500 V ~

Fast Connectors 2P+T

Description

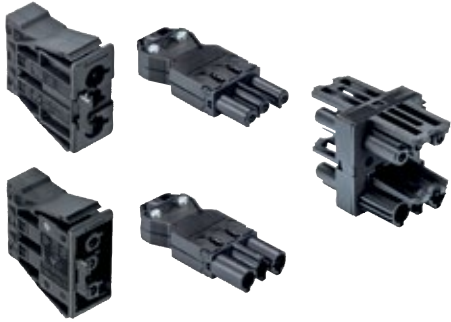

Ref. 83150 | 83151 | 83152 | 83153 | 83154

Fast Connectors 2P+T to supply the Desktop Workstations.
To be used with Modules in Ref. 45980 SBR and Ref. 45981 SBR.
Available in colours PT - Black, VM - Red.

Technical Characteristics

	83150 PT	83150 VM	83151 PT	83151 VM	83152 PT	83152 VM	83153 PT	83153 VM	83154 PT	83154 VM
Rated Current	20 A									
Rated Voltage	250 V ~									
Colour	Black	Red	Black	Red	Black	Red	Black	Red	Black	Red
Pole marking	L, N, PE									
Rigid section (Min. / Max.)	0,75 mm ² / 2,5 mm ²				0,5 mm ² / 2,5 mm ²				-	-
Flexible section (Min. / Max.)	0,75 mm ² / 2,5 mm ²				0,5 mm ² / 1,5 mm ²				-	-
Cable diameter (Min. / Max.)	6,5 mm / 10,5 mm				-				-	-
Number of terminals per pole	2								-	-
Connector type	Male	Male	Female	Female	Male	Male	Female	Female	-	-
Connection type	Screw				Screwless				-	-
Connection angle	Flat								-	-
Connection fixation	Snap-on									
Inputs Number	1									
Outputs Number	1								3	
Distribution type	-								H	

Dimensions (mm)

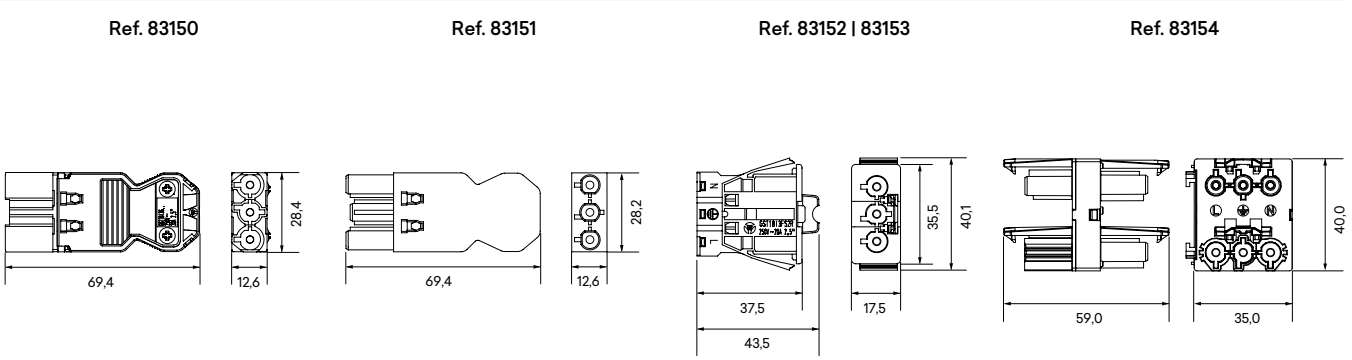



efapel.com



Serpins,
3200-355 Serpins
Portugal

Export
export@efapel.com
+351 239 970 135

SAT Technical Support Service
sat@efapel.com
+351 239 970 132

